



AMPHENOL PCD SHENZHEN



# EXCEL | MATE

## High Voltage Safety Lock

[www.amphenolpcd.com.cn](http://www.amphenolpcd.com.cn)

INDUSTRIAL@AMPHENOL  
TRUSTED GLOBALLY

# Excel|Mate PT (HVPT)

## Excel|Mate PT (HVPT - PASS-THROUGH WITH CABLE GLAND)



MECHANICAL	
Wire range	25 to 70 mm <sup>2</sup> shielded wires
Connection type	Crimping
ELECTRICAL	
Rated voltage	1000V DC
Dielectric withstand voltage	3000V AC
Shielding	360° from wire to device
ENVIRONMENTAL	
Sealing	IP67, IP6K9K (mated)
Temperature range	-40°C to 125°C
MATERIAL	
Housing	PA66 + GF

### KEY FEATURES

- 1 to 3 positions available
- Light in weight with plastic shell
- Easy to install, reliable connection
- Sealing, IP67 (mated), IP6K9K
- Multiple coding positions
- 360° shielded from wire to device
- Economical

## 1 POSITION PASS-THROUGH



## CONTACTS

Part number	Conductor cross section (mm <sup>2</sup> )	Cable OD
HVPT 1 X 70	70	19.0±0.3
HVPT 1 X 50	50	16.5±0.3
HVPT 1 X 35	35	14.2±0.3
HVPT 1 X 25	25	11.9±0.3

## INSERT ORIENTATIONS

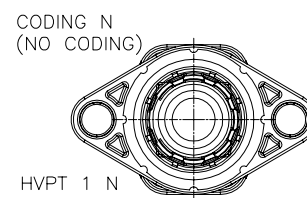
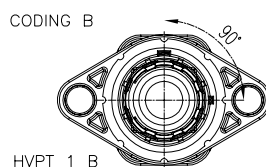

PANEL MOUNTING DIMENSIONS



PANEL MOUNTING DIMENSIONS



RECOMMENDED LAYOUT FOR 2 UNITS



RECOMMENDED LAYOUT FOR 3 UNITS



# Excel|Mate PT (HVPT)

## 2 POSITION PASS-THROUGH



## CONTACTS

Part number	Conductor cross section (mm <sup>2</sup> )	Cable OD
HVPT 2 X 70	70	19.0±0.3
HVPT 2 X 50	50	16.5±0.3
HVPT 2 X 35	35	14.2±0.3
HVPT 2 X 25	25	11.9±0.3

## INSERT ORIENTATIONS



PANEL MOUNTING DIMENSIONS

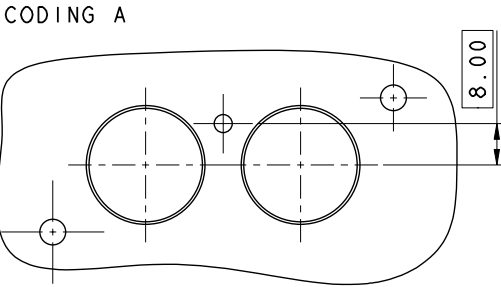
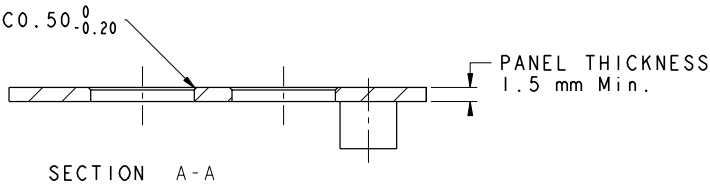

## 3 POSITION PASS-THROUGH



## CONTACTS

Part number	Conductor cross section (mm <sup>2</sup> )	Cable OD
HVPT 3 X 70	70	19.0±0.3
HVPT 3 X 50	50	16.5±0.3
HVPT 3 X 35	35	14.2±0.3
HVPT 3 X 25	25	11.9±0.3

## INSERT ORIENTATIONS





PANEL MOUNTING DIMENSIONS

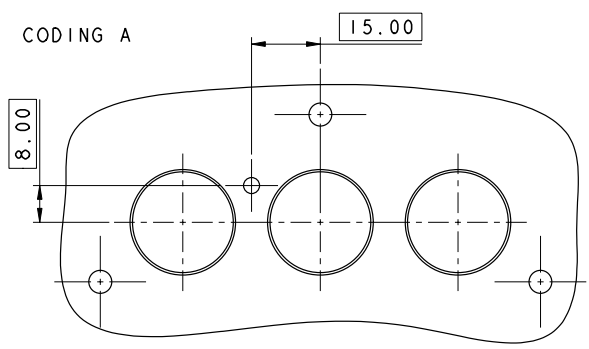
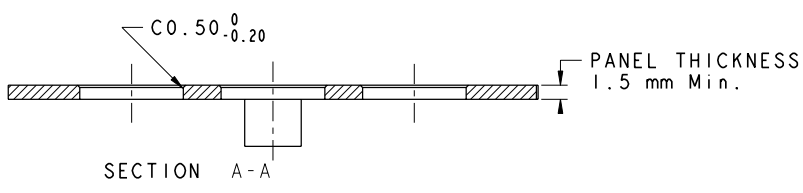
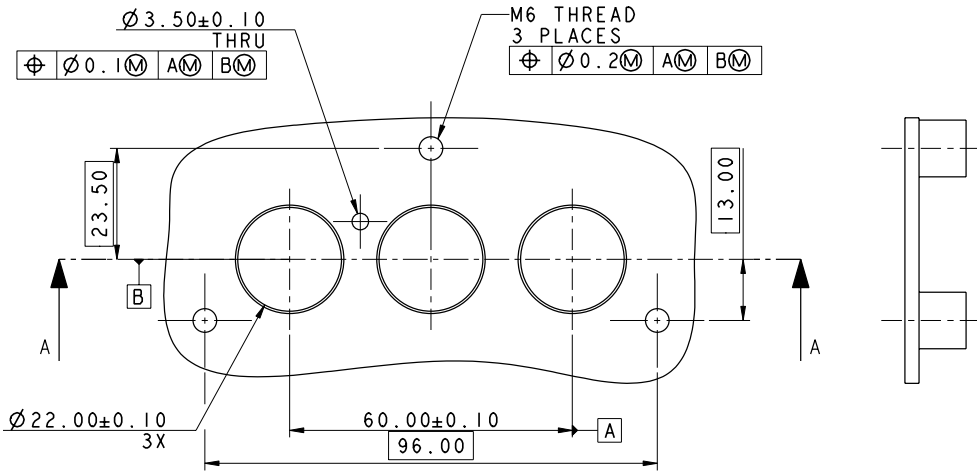

Amphenol PCD Shenzhen

Building 21  
1st Liao Keng Industrial Zone  
Shi Yan Street, Bao An District Shenzhen 518108  
China

Tel.: +86 755-8173-8000  
Fax: +86 755-8173-8180  
Email: [inquiry@amphenolpcd.com.cn](mailto:inquiry@amphenolpcd.com.cn)

[www.amphenolpcd.com.cn](http://www.amphenolpcd.com.cn)

Notes:

Amphenol PCD Shenzhen has made every effort to ensure that the information contained in this catalog is accurate at the time of publication. Specifications or information stated in this publication are subject to change without notice.

Amphenol PCD Shenzhen reserves the right to clarify this catalog.

# Mouser Electronics

Authorized Distributor

Click to View Pricing, Inventory, Delivery & Lifecycle Information:

## Amphenol:

[HVPT2A50](#) [HVPT1A25](#) [HVPT1A70](#) [HVPT1N70](#) [HVPT1B25](#) [HVPT2A25](#) [HVPT1E50](#) [HVPT1E70](#) [HVPTB3N70](#)  
[HVPT1N25](#) [HVPT1D35](#) [HVPTB2B35](#) [HVPTB3N35](#) [HVPT1C25](#) [HVPT1N50](#) [HVPTB3N50](#) [HVPT3A25](#) [HVPT1B35](#)  
[HVPT1A50](#) [HVPT1C50](#) [HVPT1C70](#) [HVPT3A70](#) [HVPT1A35](#) [HVPT1B70](#) [HVPT1E25](#) [HVPT1E35](#) [HVPTB2B50](#)  
[HVPT1D50](#) [HVPT3A35](#) [HVPT1D25](#) [HVPTB2B70](#) [HVPT1C35](#) [HVPT3A50](#) [HVPT2A70](#) [HVPT1N35](#) [HVPT1B50](#)  
[HVPT2A35](#) [HVPT1D70](#) [HVPTB3N25](#) [HVPTB2B25](#)